

IR Video Thermometer User Manual



**Please read this manual before switching the unit on.
Important safety information inside.**

Contents	Page
1. Introduction.....	4
2. Features.....	4
3. Specifications.....	5
4. Front Panel And Button Description.....	7
5. Menu Overview.....	8
6. Function.....	16
7. Notes.....	20
8. Emissivity Values.....	21
9. Maintenance.....	21

1. Introduction

Thank you for purchasing the IR VIDEO Thermometer which is capable of non-contact (infrared) temperature measurements with visual camera at the touch of a button. The built-in laser pointer increases target accuracy while the backlight LCD and handy push-buttons combine for convenient, ergonomic operation.

The IR VIDEO Thermometer can be used to measure the surface temperature of the objects that is improper to be measured by traditional (contact) thermometer (such as moving object, the surface with electricity current or the objects which are uneasy to be touched.) Proper use and care of this meter will provide years of reliable service.

2. Features

- 2.2" TFT LCD display
- 640*480 pixels(30 million pixels)
- Micro SD memory card
- Image (JPEG) and video (AVI)
- Humidity and Air Temperature
- Dual laser targeting
- Type-K thermocouple probe
- Adjustable emissivity
- High accuracy
- Fast response time
- Dewpoint temperature and Wet bulb temperature



Distance & Spot Size

As the distance (D) from the object increases, the spot size (S) of the area measured by the unit becomes larger. The relationship between distance and spot size for each unit is listed below. The focal point for each unit is 914mm (36"). The spot sizes indicate 90% encircled energy.

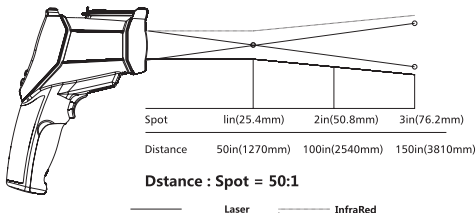

3. Specifications

IR temperature measurement

Temperature Range	-50 to 1000°C(-58 to 1832°F)
	-50 to 1600°C(-58 to 2912°F)
	-50 to 2200°C(-58 to 3992°F)
D:S	50:1
Accuracy	±1%±1.0°C(1.8°F) 20 to 500°C(68 to 932°F)
	±1.5% 500 to 1000°C(932 to 1832°F)
	±2.0% 1000 to 2200°C(1832 to 3992°F)
	±3.5°C(6.3°F) -50 to 20°C(-58 to 68°F)
Display resolution	0.1°C(0.1°F) <1000
	1°C(1°F) >1000
Repeatability	±1.5°C(2.7°F) -50 to 20°C(-58 to 68°F)
	±0.5% or ±0.5°C(0.9°F) 20 to 1000°C(68 to 1832°F)
	±1.0% 1000 to 2200°C(1832 to 3992°F)
Response Time	150mS
Spectral Response	8~14um
Emissivity	Digitally adjustable form 0.10 to 1.00

Type-k temperature measurement

Temperature Range	-50 to 1370°C(-58 to 2498°F)	
Accuracy	$\pm 0.5\% \pm 1.5^\circ\text{C}(2.7^\circ\text{F})$	0 to 1370°C(32 to 2498°F)
	$\pm 2.5^\circ\text{C}(4.5^\circ\text{F})$	-50 to 0°C(-58 to 32°F)
Display resolution	0.1°C(0.1°F)	<1000
	1°C(1°F)	>1000

Air Temperature And Relative Humidity Measurement

Air Temperature Range	0 to 50°C(32 to 122°F)
Dewpoint Temperature Range	0 to 50°C(32 to 122°F)
Relative Humidity Range	0 to 100% RH
Air temperature Accuracy	$\pm 0.5^\circ\text{C}(0.9^\circ\text{F})$ 10 to 40°C $\pm 1.0^\circ\text{C}(1.8^\circ\text{F})$ others
Dewpoint temperature Accuracy	$\pm 0.5^\circ\text{C}(0.9^\circ\text{F})$ 10 to 40°C $\pm 1.0^\circ\text{C}(1.8^\circ\text{F})$ others
Relative Humidity Accuracy	$\pm 3\%RH$ 40% to 60% $\pm 3.5\%RH$ 0% to 40% and 60% to 80% $\pm 5\%RH$ 0% to 20% and 80% to 100%
Operating Temperature	0 to 50°C(32 to 122°F)
Storage Temperature	-10 to 60°C(14 to 140°F)
Relative Humidity	10 to 90%RH non-condensing
Display	2.2" 320*240 color LCD with backlight

Power

Battery	Rechargeable battery
Battery Life	About 4 hours continuous use
Battery Charge Time	About 2 hours with AC adapter or USB connection
Size(H*W*L)	205mm*62mm*155mm
Weight	410g

4. Front Panel And Button Description

Item-Description

1-LCD Display

2-BUTTONS

3-Battery Cover

4-Measurement Trigger

5-Retractable Lens Cover

6-Visual camera

7-Laser

8-IR sensor

9-Type-k thermocouple socket

10-USB computer interface socket

11-Micro SD memory card

12-Battery

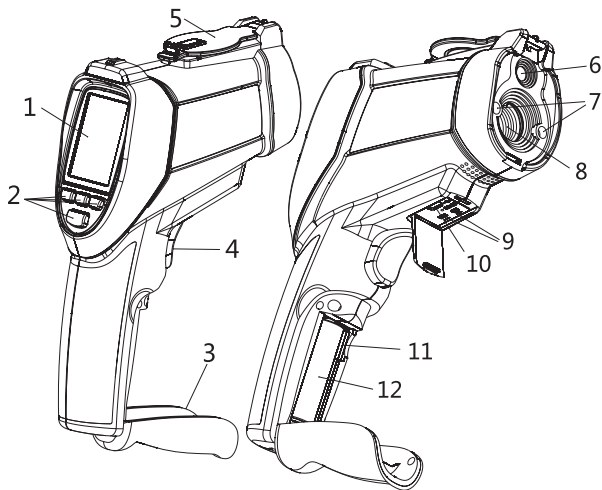

Item-Description

- 1-UP or Picture button
- 2-ESC button
- 3-Down or VIDEO button
- 4-Mode button





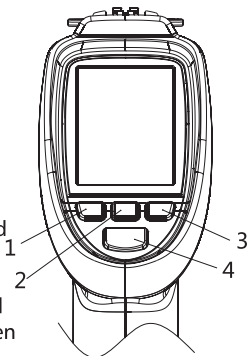

5. Menu Overview**Power on or power off**

- On the power off mode, press and hold ESC button, until the LCD is on, then the unit will power on.
- On the power on mode, Press and hold the ESC button, until the LCD is off, then the unit will power off.





**5.1 Measurement Mode**





The IR VIDEO thermometer has six modes. On the power on mode, press the ESC button, the unit will display the six modes. You can use UP or DOWN button to select any mode you need.

Items	Description
CAM mode	measure the IR temp, air temp. & air humi. With camera
IR mode	measure the IR temp. Very fast
DEWPOINT	measure the IR temp. And dewpoint temp
DATALOG	Datalog mode
GALLERY	display the picture/ datalog and video
SETTINGS	setting parameter

	IR CAM
	IR MEASURE
	DEWPOINT
	DATALOG
	GALLERY
	SETTINGS

Symbols

Symbols	Description
	CAM mode
	IR mode
	DEWPOINT mode
	Laser
	Scan

Symbols	Description
	High alarm
	High alarm working
	Low alarm
	Low alarm working
	Hold

5.2 CAM Mode

- Use to measure IR temp, air temp, air humi, dewpoint temperature and wet bulb temperature with camera. It is can display the IR MAX temp., MIN temp, DIF temp, AVG temp.
- Press and hold trigger to measure the temperature. This mode can take picture and take video.



5.2.1 take picture function

On the CAM mode, press the▲button to enter picture taking, then press SAVE with▲button to save pictures, or press CENCEL with▼button to cancel.



5.2.2 take video function.



On the CAM mode, press the▼button to enter video taking mode, then press START with▼button to take videos, or press ESC button to esc.



press STOP with▼button to stop the video.

5.3 IR Mode

Use to measure IR temp, air temp, air humi, dewpoint temperature and wet bulb temperature without camera. It can display the IR MAX temp, MIN temp, DIF temp, AVG temp. Press and hold trigger to measure the temperature.



5.4 DEWPOINT Mode



measure the IR temp. and dewpoint temp. Press and hold trigger to measure the temperature.

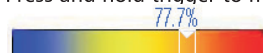

This is that the IR temperature and dewpoint temperature close to the percentage of.

5.5 Data log

In the DATALOG mode, first set the parameter, like high alarm value, low alarm value, interval time, and the line color, then press the trigger to start logging. The unit will automatically record data, press the ESC button to esc the DATALOG mode, then the data will automatically save.

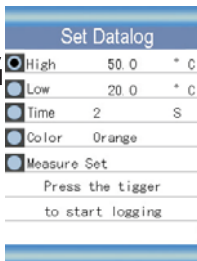

Set the datalog parameter

Set high alarm value

Press the ENTER button, use the ▲ and ▼ button to adjust the value, then press the ENTER button to confirm.

Set low alarm value

Press the ENTER button, use the ▲ and ▼ button to adjust the value, then press the ENTER button to confirm.

Set interval time

Press the ENTER button, use the ▲ and ▼ button to adjust the value, then press the ENTER button to confirm.

Select the color

Press the ENTER button, use the ▲ and ▼ button to select the color, then press the ENTER button to confirm.

5.6 Gallery

Items	Descriptions
Picture	Display the saved pictures
Video	Play the saved videos
Logs	Display the data log and view

- Press the ▲ and ▼ button to select the picture, video or Logs. Then press the ENTER button to enter.
- In the picture. Video or logs, press the ENTER button to view picture, play video or view log. Then press the ENTER button to delete the picture, video or log. Press the ▲ button to confirm to delete, press ▼ button to cancel.



CONFIRM

NO

5.7 SETTINGS



Items	Descriptions
Date/Time	Set date and time
Units(C/F)	Select the temperature unit
Language	Select language
Font Color	Select the font color
Cursor	Select cursor or off
Backlight	Backlight brightness adjustment
Auto Power off	Select auto power off time
Screen Timeout	Select screen auto off time
Keypress Alert	Able or disable of Keypress Alert
Memory Status	Display the memory and SD card capacity
Factory Setting	Restore factory settings

Press the ▲ and ▼ button to select the Items, Then press the ENTER button to enter.

5.7.1 Date/Time

Press the ▲ and ▼ button to select the value, press the ENTER button to set the next value, press ESC button to esc and save the date and time.

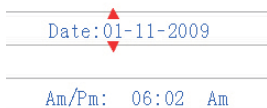

5.7.2 Units(C/F)

Press the▲ and▼ button to select the unit, press the ESC button to esc and save.

- ° C
- ° F

5.7.3 Language

Press the▲ and▼ button to select the language, press the ESC button to esc and save.

- English
- German

5.7.4 Font Color

Press the▲ and▼ button to select the color, press the ESC button to esc and save.

- Orange
- Green
- Black
- Blue
- Gold
- Purple

5.7.5 Cursor

Press the▲ and▼ button to select the cursor (off, cross or circle), press the ESC button to esc and save.

- Off
- Cross
- Circle

5.7.6 Backlight

Press the ▲ and ▼ button to select the backlight brightness, press the ESC button to esc and save.

- 100%
- 90%
- 80%
- 70%
- 60%
- 50%
- 40%
- 30%

5.7.7 Auto Power off

Press the ▲ and ▼ button to select the auto power off time or never auto power off, press the ESC button to esc and save.

- Disabled
- 3 Min
- 15 Min
- 60 Min

5.7.8 Screen Timeout

Press the ▲ and ▼ button to select the screen auto off time or never screen auto off, press the ESC button to esc and save.

- Disabled
- 30s
- 1 Min
- 2 Min

5.7.9 Keypress Alert

Press the ▲ and ▼ button to enable or disable the keypress alert, press the ESC button to esc and save.

Enable

Disable

5.7.10 Memory Status

Press the ▲ and ▼ button to select the memory (flash or SD). Press the ESC button to esc and save.

NOTE: If SD card inserted, SD card will be selected by default.

Device Memory

SD Card

Device Memory

SD Card

Total: [49]MB

Used: [0]MB

Free: [49]MB (100)%

Total: [49]MB

Used: [0]MB

Free: [49]MB (100)%

CONFIRM

NO

Press the ENTER button to format the flash or SD card, press ▲ button to cancel format, press ▼ button to confirm format.

5.7.10 Factory Setting

Press the ▲ and ▼ button to select yes or no restore factory settings. Press the ESC button to esc and save.

No

Yes

6. Function

On any mode, press the ENTER button into the menu.Measure set

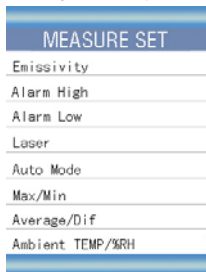

Items	Descriptions
Emissivity set	Set the emissivity
Alarm High	On or off the high alarm and set the value
Alarm Low	On or off the low alarm and set the value
Laser	Able or disable of laser
Auto Mode	Lock to continue measure
Max/Min	Display the max. or min. IR temperature
Average/Dif	Display the average or difference of IR temp.
Ambient TEMP/% RH	Display the air temperature and humidity
Dewpoint/wet bulb	Display the dewpoint and wet bulb temperature
Type k	Enable or disable the type-k input

6.1 Emissivity set

ON the first line ($\epsilon=0.94$), press the ENTER button to adjust emissivity, Press the▲ and▼ button to adjust the value, then press the ENTER button conform. Press the and button to select the emissivities of the materials, press the ESC button to esc and save.

- $\epsilon=0.94$
- Concrete
- Glass
- Human Skin
- Ice/water
- Plastic
- wood

6.2 Alarm High

Press the▲ and▼ button to on or off the high alarm. If the high alarm is on, press the ENTER button to adjust, press the▲ and▼ button to adjust value. Press the ENTER button to conform, press the ESC button to esc and save.

- Enable 1000.0 ° C
- Disable

6.3 Alarm Low

Press the ▲ and ▼ button to on or off the low alarm. If the low alarm is on, press the ENTER button to adjust, press the ▲ and ▼ button to adjust value. Press the ENTER button to conform, press the ESC button to esc and save.

Enable -50.0 ° C

Disable

6.4 Laser

Press the ▲ and ▼ button to enable or disable laser, press the ESC button to esc and save.

Enable

Disable

6.5 Auto Mode

Press the ▲ and ▼ button to enable or disable auto mode, press the ESC button to esc and save.

If enable the auto mode, the unit will automatic continue measure, on the status, press the ENTER button, and then press UP button to exit the lock status, press the DOWN button to on or off the laser.

Enable

Disable

CANCEL 

6.6 Max/Min

Press the ▲ and ▼ button to on or off display the max. or min. IR temperature, press the ESC button to esc and save.

 ON OFF

6.7 Average/Dif

Press the ▲ and ▼ button to on or off display the average or difference of IR temp, press the ESC button to esc and save.

 ON OFF

6.8 Ambient TEMP/% RH

Press the ▲ and ▼ button to on or off display the air temperature and humidity, press the ESC button to esc and save.

 ON OFF

6.9 Dewpoint/wet bulb

Press the ▲ and ▼ button to on or off display the dewpoint and wet bulb temperature, press the ESC button to esc and save.

 ON OFF

6.10 Type k

Press the ▲ and ▼ button to enable or disable Type k input, and then press the ESC button to esc and save.

NOTE: If insert Type-k probe, Enable will be selected by default. Users can select the Disable, prohibiting LCD display Type-k temperature.

7. Notes

•How it Works

Infrared thermometers measure the surface temperature of an object. The unit's optics sense emitted, reflected, and transmitted energy, which is collected and focused onto a detector. The unit's electronics translate the information into a temperature reading, which is display on the unit. In units with a laser, the laser is used for aiming purposes only.

•Field of View

Make sure that the target is larger than the unit's spot size. The smaller the target is, the closer you should be to it. When accuracy is critical, make sure the target is at least twice as large as the spot size.

•Distance & Spot Size

As the distance (D) from the object increases, the spot size (S) of the area measured by the unit becomes larger. See: Fig: 1.

•Locating a hot Spot

To find a hot spot aim the thermometer outside the area of interest, then scan across with an up and down motion until you locate hot spot.

•Reminders

A:Do not use the unit to measure shiny or polished metal surfaces (stainless steel, aluminum, etc.).See Emissivity.

B:The unit cannot be measured through transparent surfaces such as glass. It will measure the surface temperature of the glass instead.

C:Steam, dust, smoke, etc, Can prevent accurate measurement by obstructing the unit's optics.

•Emissivity

Emissivity is a term used to describe the energy-emitting characteristics of materials.

Most (90% of typical applications) organic materials and painted or oxidized surfaces have an emissivity of 0.95 (pre-set in the unit). Inaccurate readings will result from measuring shiny or polished metal surfaces. To compensate, cover the surface to be measured with masking tape or flat black paint. Allow time for the tape to reach the same temperature as the material underneath it. Measure the temperature of the tape or painted surface.

8. Emissivity Values

Substance	Thermal emissivity	Substance	Thermal emissivity
Asphalt	0.90 to 0.98	Cloth (black)	0.98
Concrete	0.94	Human skin	0.98
Cement	0.96	Lather	0.75 to 0.80
Sand	0.90	Charcoal (powder)	0.96
Earth	0.92 to 0.96	Lacquer	0.80 to 0.95
Water	0.92 to 0.96	Lacquer (matt)	0.97
Ice	0.96 to 0.98	Rubber (black)	0.94
Snow	0.83	Plastic	0.85 to 0.95
Glass	0.90 to 0.95	Timber	0.90
Ceramic	0.90 to 0.94	Paper	0.70 to 0.94
Marble	0.94	Chromium oxides	0.81
Plaster	0.80 to 0.90	Copper oxides	0.78
Mortar	0.89 to 0.91	Iron oxides	0.78 to 0.82
Brick	0.93 to 0.96	Textiles	0.90

9. Maintenance

- Repairs or service are not covered in this manual and should only be carried out by qualified trained technician.
- Periodically, wipe the body with a dry cloth. Do not use abrasives or solvents on this instrument.
- For service, use only manufacturer's specified parts.

Rev.101122

française
d'instrumentation 

DISTRAME SA

Parc du Grand Troyes - Quartier Europe Centrale
40 rue de Vienne - 10300 SAINTE SAVINE

Tel : 03 25 71 25 83 - Fax : 03 25 71 28 98
www.distrame.fr - e-mail : infos@distrame.fr

